



KONICA MINOLTA

DIRECT DIGITIZER

REGIUS MODEL 190



The essentials of imaging

Succeeding the "Ultimate Resource Sharing System"
concept introduced in REGIUS MODEL 170,
the new REGIUS MODEL 190 features a new 43.75 μ m read function
for mammography, the finest in the world.
The REGIUS Console has also been enhanced with new functions
to provide more powerful tools.
Introducing the New REGIUS, even easier to use,
even more refined.



43.75 μ m

REGIUS MODEL 190



A new Compact, high-performance design.

Utilizing a unique dual bay design, the high speed reader of REGIUS Model 190 processes up to 90 plates per hour for maximum performance. This next generation reader radically improves workflow all within a mere 58×58 cm footprint.



Centralized image checking for flexible layout

The "Ultimate Resource Sharing" concept provides the flexibility to separate the location of the consoles and the readers. This allows for the same fast and thorough image checking as with conventional systems. The result: system layout and productivity are optimized according to the number of examinations conducted, the work line and floor space.

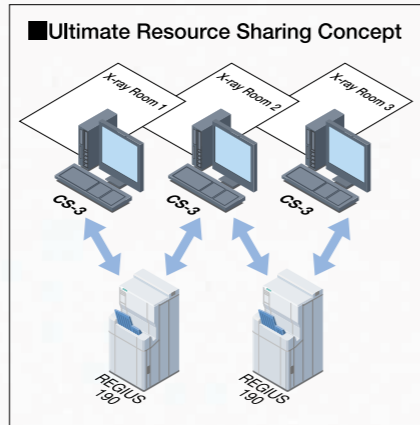

Featuring a new cassette size to provide the ideal examination environment.

In addition to the world's first 11"×14" size featured in REGIUS MODEL 170, the new line-up available on REGIUS MODEL 190 includes the 15×30cm size to provide even greater examination efficiency.



The "Ultimate Resource Sharing" concept enables realization of the ideal workflow in any scene of the medical institute.



2ch slot with independent insert / eject simplifies operation.

In this uniquely innovative design, the entire cassette is loaded into the front slot and ejected out of the rear slot. This helps make the examination handling process exceptionally smooth and efficient.

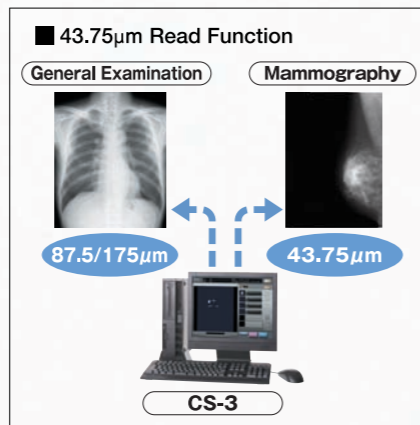

43.75µm Read Function (option)

In addition to the 175 and 87.5µm read capability, REGIUS MODEL 190 is capable of supporting a new 43.75µm read function for mammography. This function is invaluable for producing diagnostic quality for mammography images, where recognition of subtle pathological changes is essential.

M O D E L 1 9 0



REGIUS CONSOLE CS-3

CS-3 incorporates a user interface similar to that of CS-1. Both are highly regarded for their intuitiveness and simplicity. CS-3 provides the user flexibility in system configuration needed to create the ideal workflow. The unit is also equipped with a User Tool that gives complete freedom to customize image settings.

REGIUS CONSOLE CS-2

The CS-2 console used for the REGIUS Series is designed to provide the user with even greater ease and simplicity of operation. With the aim of offering a console that can be operated by anyone immediately after installation, only the most essential functions are incorporated into the CS-2 user interface. At the same time, various automated processing functions have been incorporated into CS-2 to create a highly efficient environment.

Choose the Console for your Ideal Environment

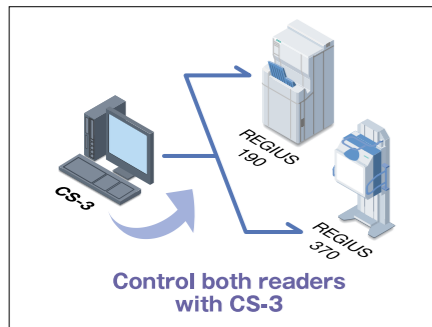

Multi-reader control.
One CS-3 unit seamlessly controls both reader units of the Model 190 and Model 370. For superior processing continuity, the flow of exposures is uninterrupted while the images are acquired.

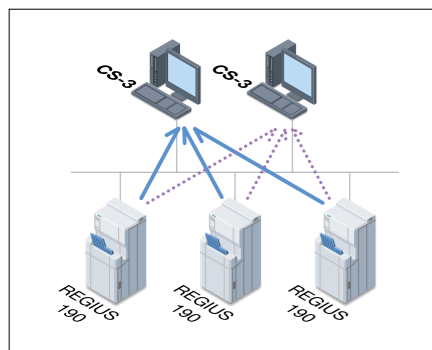

Freely Selectable Reader.
Images are always displayed on the CS-3 where the plate is registered, regardless of which the reader unit used to scan the plate. This makes it easier for the operator to check image quality while maximizing the reader utilization.



▲1image Routine Menu



▲4images Routine Menu

A better real-time display.
Shorter time from exposure to image checking is important for the user's efficiency. The CS-3 makes it possible to check the image in the least amount of time possible, since images are displayed in real time.



▲Screen Customization

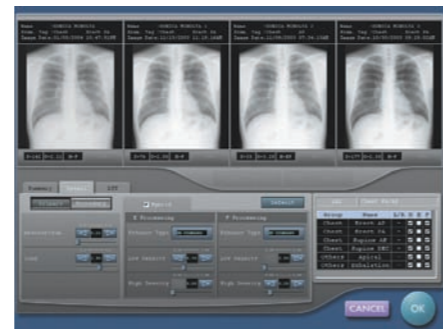

▲Image Quality Adjustment

User Tool
This tool allows the user to modify processing parameter settings, examination key layout, and other settings with ease. The operation is highly visually oriented: users can browse previous images while using slide bars to change the settings; images are then updated as the settings change. The drop and drag function for creating examination keys are also intuitive and simple to use.

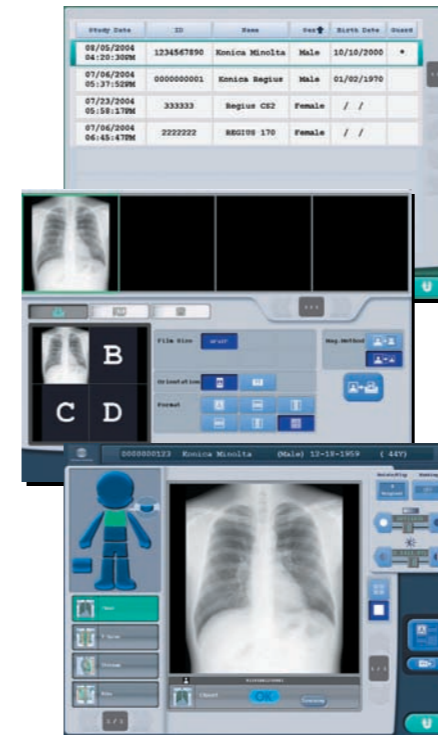

Easy User Interface (Easy GUI)
CS-2 allows the user to select the body part to be examined from the icon. Simplified screen operations, from patient registration to image verification are achieved by various automated processing function.

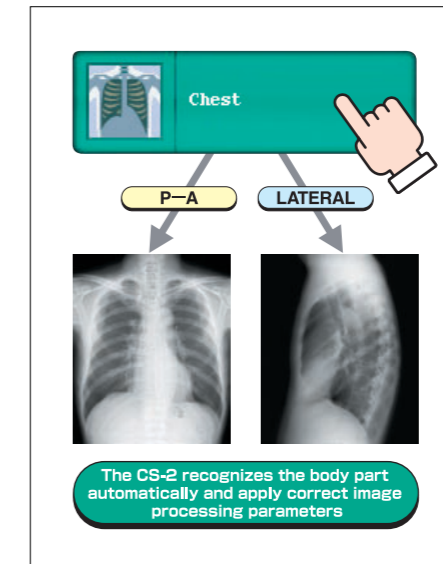

Automatic Body Part Recognition.
A comprehensive analysis of shape and density variations in the body part, and of the edge and continuity of bones, enable the CS-2 to produce an optimal image without the need for creating specific exam tag key settings.

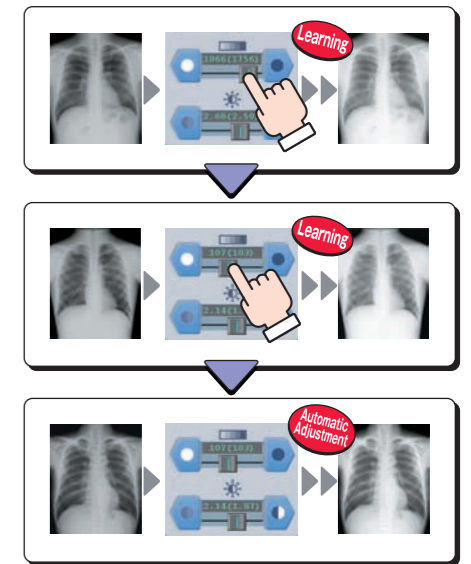

Automatic Processing Parameter Learning Function.
The CS-2 automatically memorizes preferred density and contrast adjustments made by the users and regularly calculates the average numbers for these settings. As a result, CS-2 automatically customizes image quality to match users' preference.

CONSOLE

SYSTEM

Expanding REGIUS Applications (Additional New Functions)

■ Stitching Function (option)

This function joins together images that have been exposed using dedicated REGIUS long length cassettes.

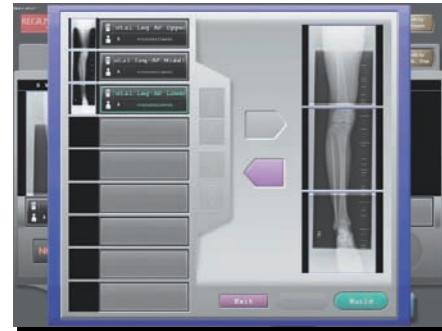

■ Annotation

This function allows the user to create free text annotations and to place them anywhere on the image. The annotations are saved as part of the image for printing or DICOM storage.



■ Data Analysis Function (option)

This option stores and tracks rejected images with user customized reasons. It provides statistics for exposure counts, reject rates, S value and other system performance data, making it a valuable tool for day to day management.



PORTABLE SYSTEM

1. Download

The Examination Order is downloaded from CS-3 to the PDA.



Examination Order

Operation Room

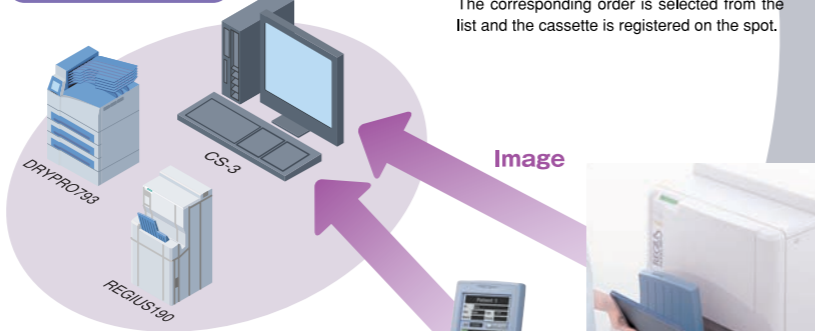

Registration Data

4. Image Check

The order and images are automatically matched and images of all patients appear on the same CS-3 screen for quick checking.



Patient's Room



2. Cassette Registration/Shooting

The corresponding order is selected from the list and the cassette is registered on the spot.



3. Reading

After registered data is uploaded from PDA to CS-3, exposed cassettes are scanned by the reader.

A Example of KONICA MINOLTA SYSTEM

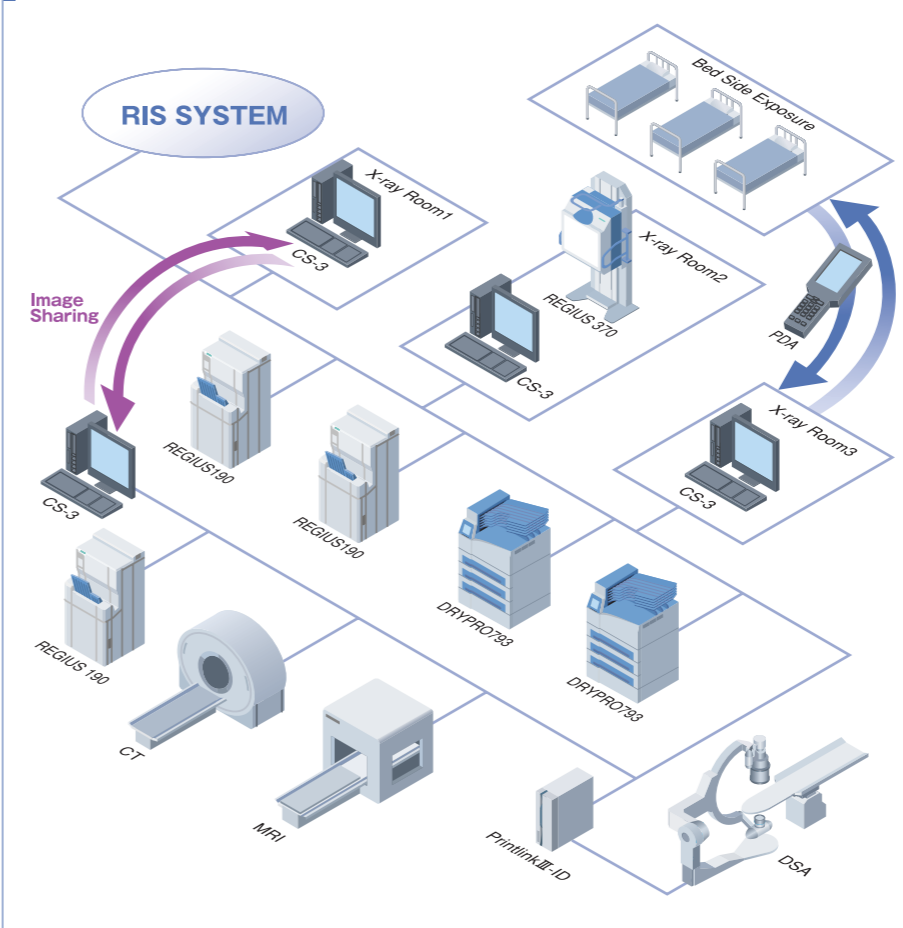

Another Example of KONICA MINOLTA SYSTEM

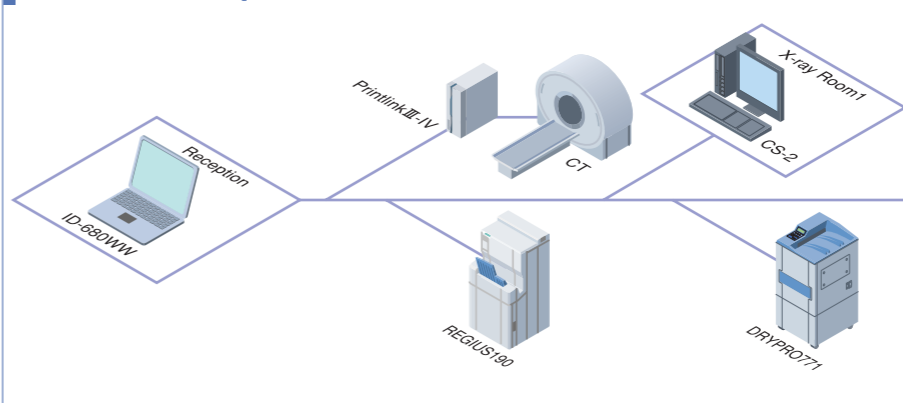

■ Image Sharing Function (option)

This function allows sharing of images among multiple consoles on the same network. Images on another CS-2/CS-3 can be accessed from a remote location for viewing and editing.

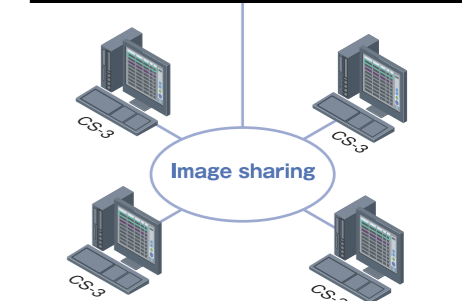
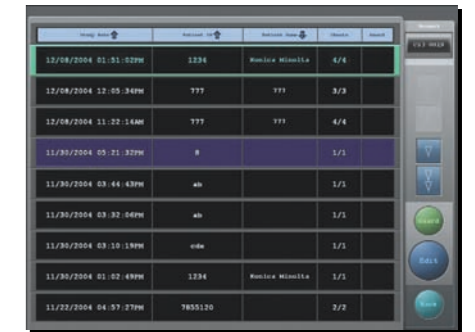

■ Patient Data Registration Function

As well as previous input from CS-3 and the search function from the RIS system, a new patient data registration function is furnished.

·ID-680WW (Option) : Used as the reception terminal. Input data is displayed in sequence on CS-2/3. A server function is also provided to enable creation of a patient database.

Once the patient data is registered, it may be accessed from any CS-2/3.



S P E C I F I C A T I O N S

Direct Digitizer REGIUS MODEL 190 (DD-941)

Exposure size

14"×17" / 14"×14" / 11"×14" / 10"×12" / 8"×10" /
18×24 cm / 24×30 cm / 15×30 cm and others

Sampling Pitch

3Types: 87.5 / 175 and 43.75 μ m for Mammography

Maximum Resolution

4020×4892 (14"×17" / 87.5 μ m)
5440×6776 (24×30cm / 43.75 μ m / Mammography)
7080×9480 (14"×17" / 43.75 μ m / PCM)

Digital Gradation Level

4096 levels (12bit)

Processing Capability

approx. 90 plates / hour (14"×14" / 175 μ m)

Cassette Feed / Load Time or Cassette Cycle Time

approx.40 seconds (14"×14" / 175 μ m)

Slots

Insert×1 (plus 1 stack)
Eject×1 (4-stack)

Outer Dimensions / Weight

W580×D580×H1230mm / approx. 170kg

Power Consumption

AC100/115/120/200/220/230/240V \pm 10%
50/60Hz approx. 1.1kW

Operating Conditions

Temperature: 15-30°C
Humidity : 40-80%RH (no condensation)

REGIUS MODEL 190 Outer Dimensions

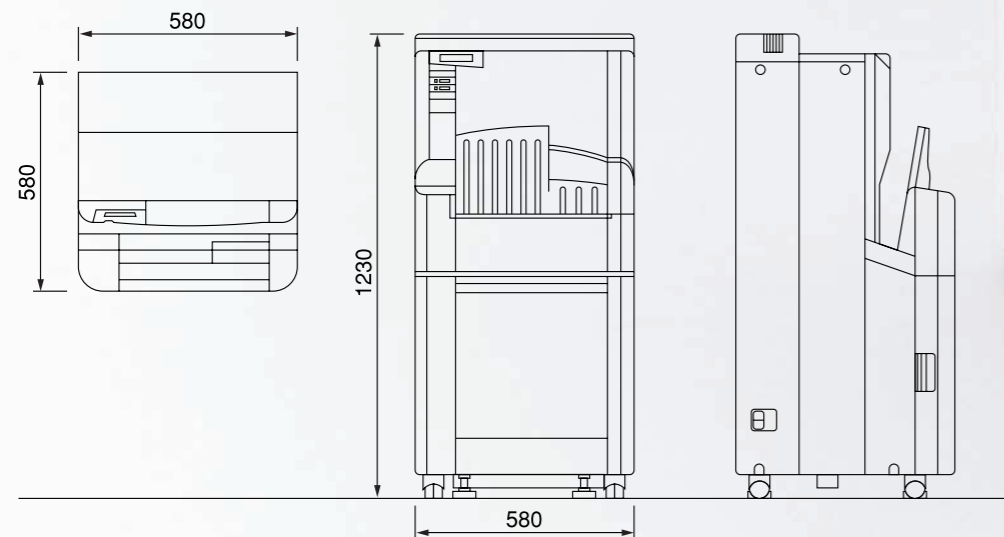

Unit: mm 1/20 scaled



REGIUS Console CS-3

Image Processing

Automatic Gradation Processing (G Processing)
Frequency Processing (F Processing)
Equalization Processing (E Processing)
Hybrid Processing (H Processing)

Image Output

•Maximum
Host : 3ch for normal, 1ch for backup
Printer : 2ch for normal, 1ch for backup
•CS-3 Standard Software
Host or Printer : 1ch for normal, 1ch for backup

DICOM Support

Basic Grayscale Print Management (SCU)
Storage (SCU)
Modality Worklist Management
Modality Performed Procedure Step
Grayscale Standard Display Function (print output)

Maximum Connection

REGIUS 170/190 16units and REGIUS 370 1unit

Output Format

1×1, 2×1, 1×2

Main Options

•Hardware option
Bar Code Reader for Cassette Registration
CS-1 PDA
CS-1 PDA CRADLE
IDS WW
•Software option
CS-3 MWM/FTP/DETACHED Option
CS-3 MPPS/DETACHED Option
CS-3 HQ Mammography Option
CS-3 DICOM Output Additional#1
CS-3 DICOM Output Additional#2
CS-3 DICOM Output Additional#3
CS-3 DICOM Output Additional#4
CS-3 DICOM Output Package
CS-3 Stitching Option
CS-3 Image Sharing Option
CS-3 Data Analysis Option



REGIUS Console CS-2

Image Processing

Automatic Gradation Processing (G Processing)
Frequency Processing (F Processing)
Equalization Processing (E Processing)
Hybrid Processing (H Processing)

Image Output

•Maximum
Host : 2ch for normal, 1ch for backup
Printer : 1ch for normal, 1ch for backup
•CS-2 Standard Software
Host or Printer : 1ch for normal, 1ch for backup

DICOM Support

Basic Grayscale Print Management (SCU)
Storage (SCU)
Modality Worklist Management
Modality Performed Procedure Step
Grayscale Standard Display Function (print output)

Automatic Image Processing Function

Automatic Body Part Recognition
Automatic Processing Parameter Study

Maximum Connection

REGIUS 170/190 2units

Output Format

1×1, 2×1, 1×2, 2×2

Main Options

•Hardware option
Bar Code Reader for Cassette Registration
IDS WW
•Software option
CS-2 MWM/FTP/DETACHED Option
CS-2 MPPS/DETACHED Option
CS-2 HQ Mammography Option
CS-2 DICOM Output Additional#1
CS-2 DICOM Output Additional#2
CS-2 DICOM Output Package
CS-2 Stitching Option
CS-2 Image Sharing Option
CS-2 Data Analysis Option





REGIUS
MODEL 190



KONICA MINOLTA

KONICA MINOLTA MEDICAL & GRAPHIC, INC.

No.1, Sakura-machi, Hino-shi, Tokyo, 191-8511, Japan

Distributed by :